

Inhaltsverzeichnis movingStar

Blatt Nr.	Beschreibung	Maßstab
Inhaltsverzeichnis		
movingStar Nr. 001	Inhaltsverzeichnis movingStar	
3D - Wandbeispiel		
movingStar Nr. 002	Schnitt durch movingStar	
movingStar Nr. 003	Beispiele Parkstellung	
Deckenanschlüsse movingStar elektrisch		
movingStar Nr. 004	Vertikalschnitt Glaselement Deckenanschluss	1:2,5
movingStar Nr. 005	Vertikalschnitt Türelement Deckenanschluss ohne Oberlicht	1:2,5
movingStar Nr. 006	Vertikalschnitt Türelement Deckenanschluss mit Oberlicht	1:2,5
Deckenanschlüsse movingStar manuell		
movingStar Nr. 007	Vertikalschnitt Glaselement Deckenanschluss	1:2,5
movingStar Nr. 008	Vertikalschnitt Türelement Deckenanschluss ohne Oberlicht	1:2,5
movingStar Nr. 009	Vertikalschnitt Türelement Deckenanschluss mit Oberlicht	1:2,5
Bodenanschlüsse movingStar		
movingStar Nr. 010	Vertikalschnitt Bodenanschluss Drehendflügel Bandseite	1:2,5
movingStar Nr. 011	Vertikalschnitt Bodenanschluss Drehendflügel Schlossseite	1:2,5
movingStar Nr. 012	Vertikalschnitt Bodenanschluss Normalelement Links / Normalelement	1:2,5
movingStar Nr. 013	Vertikalschnitt Bodenanschluss Normalelement Rechts / Normalelement	1:2,5
movingStar Nr. 014	Vertikalschnitt Bodenanschluss Normalelement Links / Drehflügel	1:2,5
movingStar Nr. 015	Vertikalschnitt Bodenanschluss Normalelement Rechts / Drehflügel	1:2,5
movingStar Nr. 016	Vertikalschnitt Bodenanschluss Drehflügel DIN Rechts - Bandseite	1:2,5
movingStar Nr. 017	Vertikalschnitt Bodenanschluss Drehflügel DIN Rechts - Schlossseite	1:2,5
movingStar Nr. 018	Vertikalschnitt Bodenanschluss Drehflügel DIN Links - Bandseite	1:2,5
movingStar Nr. 019	Vertikalschnitt Bodenanschluss Drehflügel DIN Links - Schlossseite	1:2,5
Horizontalanschlüsse movingStar		
movingStar Nr. 020	Horizontalschnitt Drehendflügel; Bandseite	1:2,5
movingStar Nr. 021	Horizontalschnitt Drehendflügel / Normalelement; Schlossseite Rechts	1:2,5
movingStar Nr. 022	Horizontalschnitt Normalelement	1:2,5
movingStar Nr. 023	Horizontalschnitt Drehflügel / Normalelement; Bandseite Links	1:2,5
movingStar Nr. 024	Horizontalschnitt Drehflügel / Normalelement; Schlossseite Rechts	1:2,5
movingStar Nr. 025	Horizontalschnitt Doppel - Drehflügel; Schlossbereich	1:2,5
movingStar Nr. 026	Horizontalschnitt Drehflügel / Normalelement; Schlossseite Links	1:2,5
movingStar Nr. 027	Horizontalschnitt Drehflügel / Normalelement; Bandseite Rechts	1:2,5
movingStar Nr. 028	Horizontalschnitt Wandanschlusselement	1:2,5

movingStar über: MONOWA Flexible Trennwandsysteme GmbH, Austraße 28, 71739 Oberriexingen

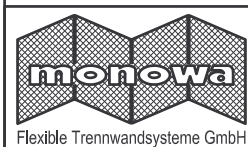

Produkt / product

movingStar

Maßstab / scale

Beschreibung / description

Inhaltsverzeichnis

Blatt Nr. / no. sheet
movingSTAR
001



movingStar über: MONOWA Flexible Trennwandsysteme GmbH, Austraße 28, 71739 Oberriexingen

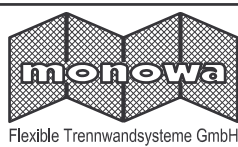

Produkt / product

movingStar

Maßstab / scale

Beschreibung / description

3D-Ansicht movingStar

Blatt Nr. / no. sheet
movingSTAR
002

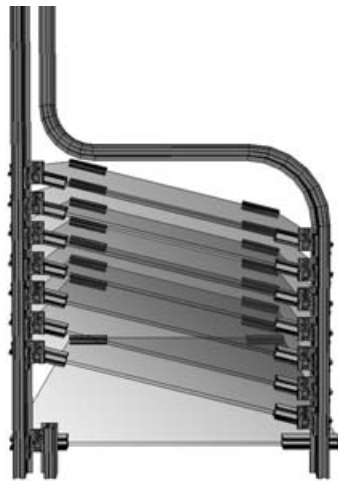

H-Parkstellung, Schräg 90°

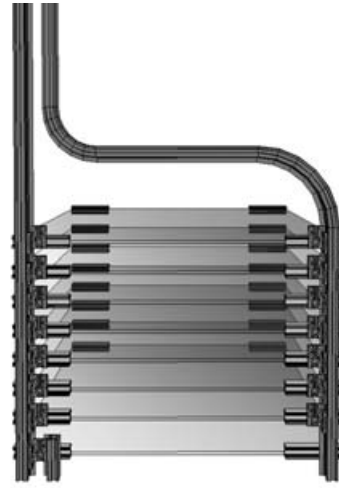

H-Parkstellung, gerade 90°

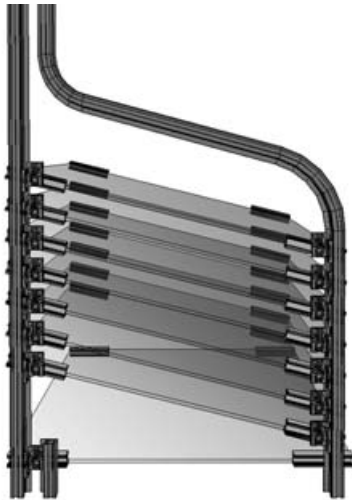

H-Parkstellung, schräg 105°

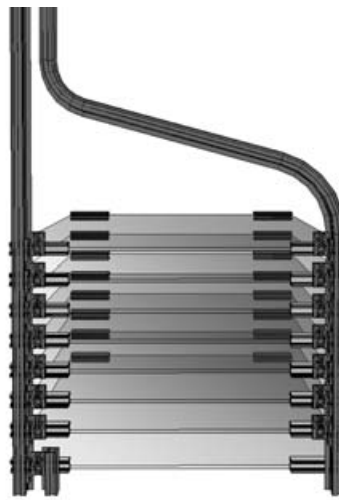

H-Parkstellung, gerade 105°

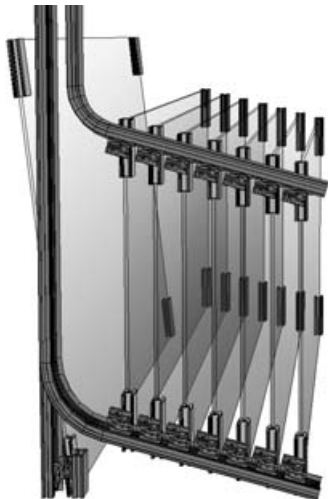

L-Parkstellung 105°

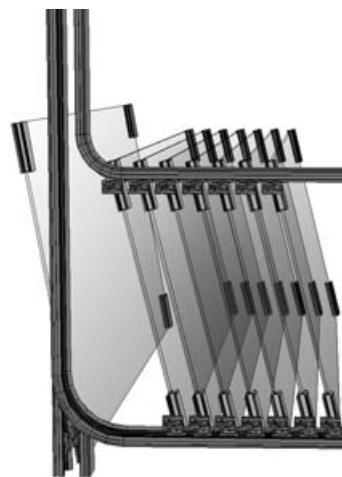

L-Parkstellung 90°

movingStar über: MONOWA Flexible Trennwandsysteme GmbH, Austraße 28, 71739 Oberriexingen

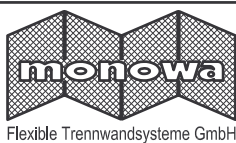

Produkt / product

movingStar

Maßstab / scale

Beschreibung / description

Beispiele Parkstellung

Blatt Nr. / no. sheet
movingSTAR
003

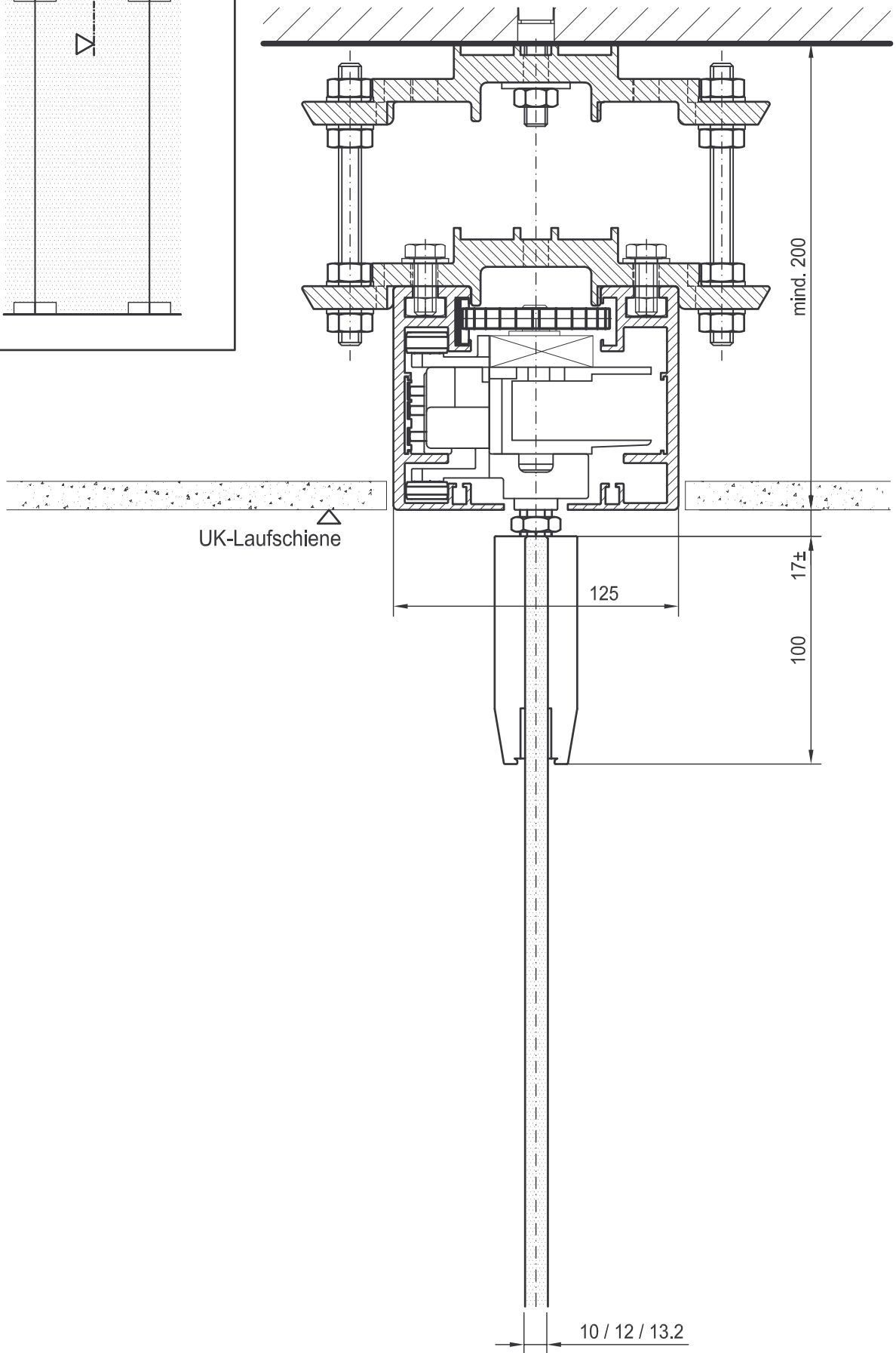
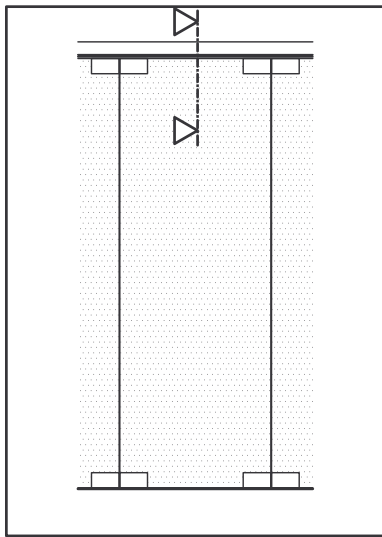

movingStar über: MONOWA Flexible Trennwandsysteme GmbH, Austraße 28, 71739 Oberriexingen



Produkt / product

movingStar / elektrisch

Maßstab / scale 1 : 2,5

Beschreibung / description

Vertikalschnitt Glaselement
Deckenanschluss

Blatt Nr. / no. sheet
movingSTAR elektrisch
004

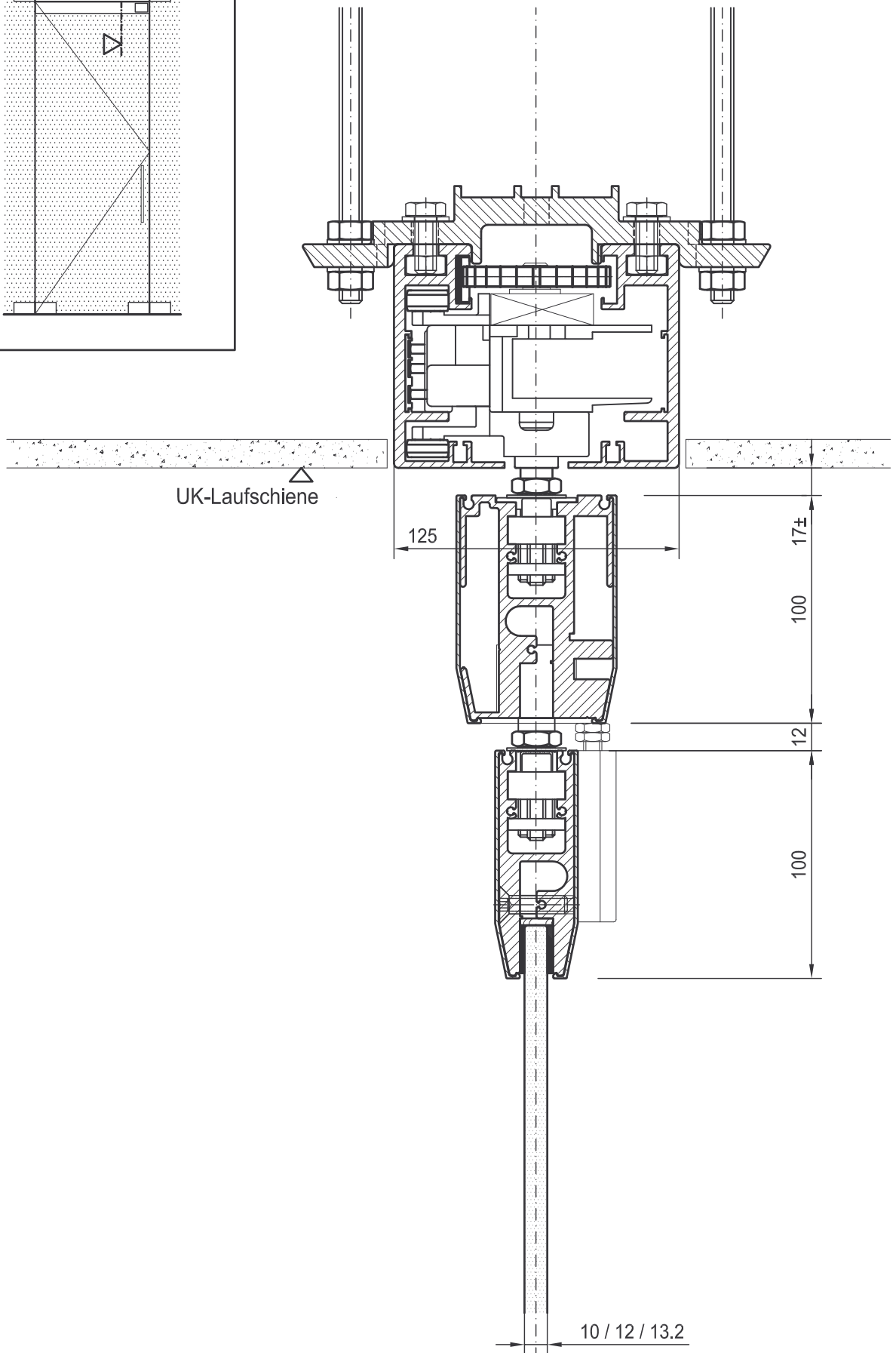
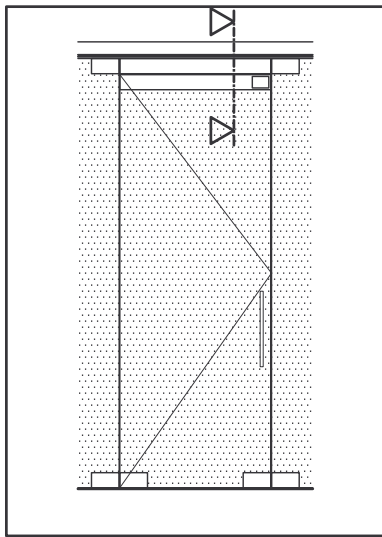

movingStar über: MONOWA Flexible Trennwandsysteme GmbH, Austraße 28, 71739 Oberriexingen



Produkt / product

movingStar / elektrisch

Maßstab / scale 1 : 2,5

Beschreibung / description

Vertikalschnitt Türelement
Deckenanschluss ohne Oberlicht

Blatt Nr. / no. sheet
movingSTAR
005

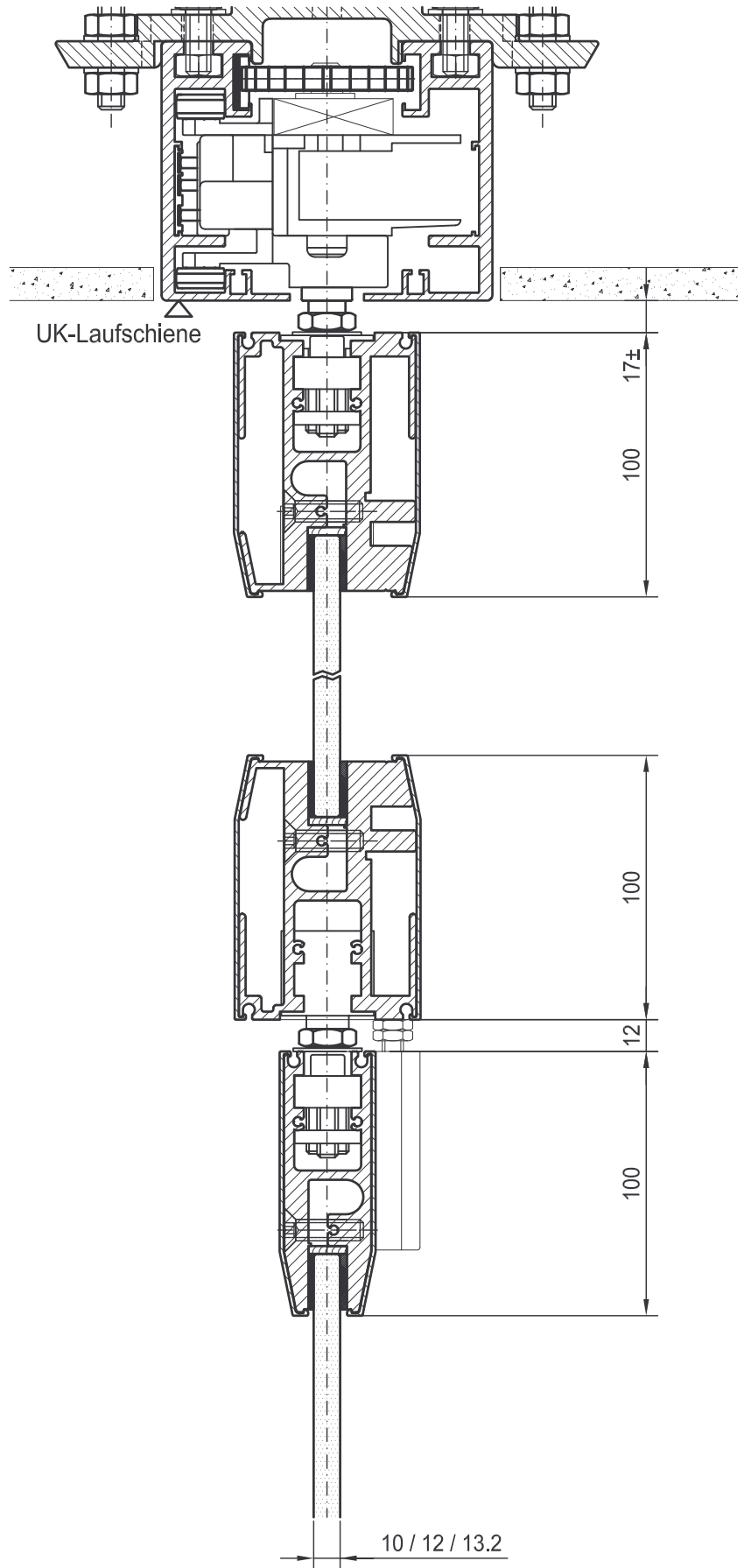
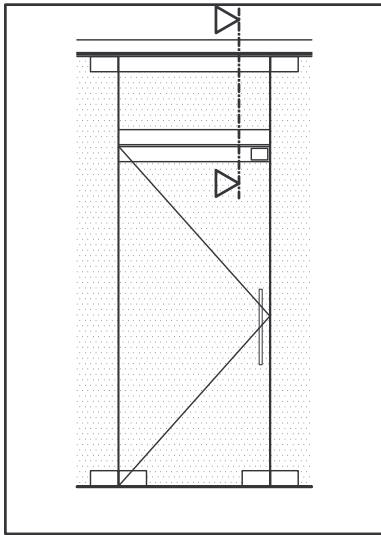

movingStar über: MONOWA Flexible Trennwandsysteme GmbH, Austraße 28, 71739 Oberriexingen



Produkt / product

movingStar / elektrisch

Maßstab / scale 1 : 2,5

Beschreibung / description

Vertikalschnitt Türelement
Deckenanschluss mit Oberlicht

Blatt Nr. / no. sheet
movingSTAR
006

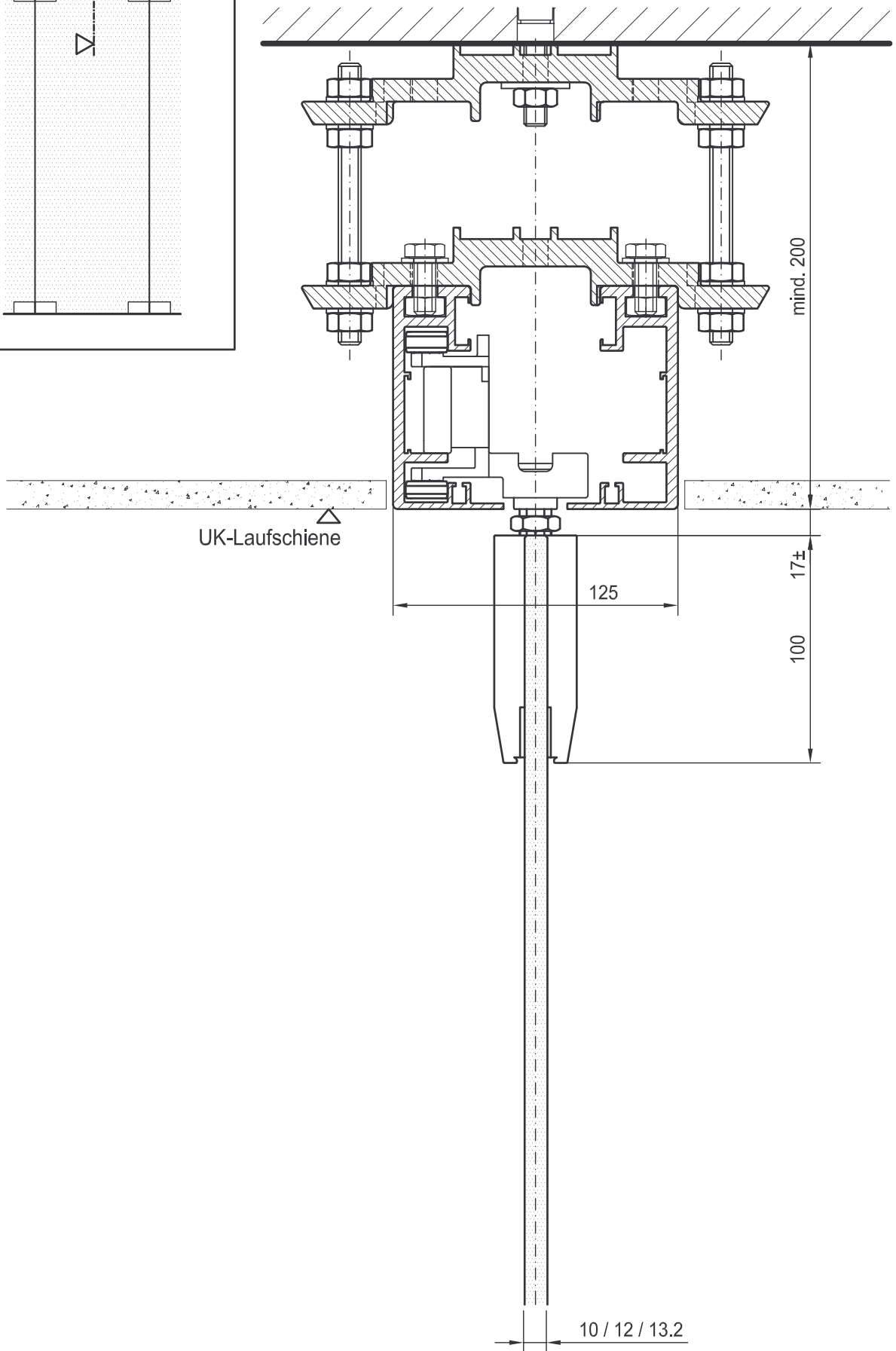
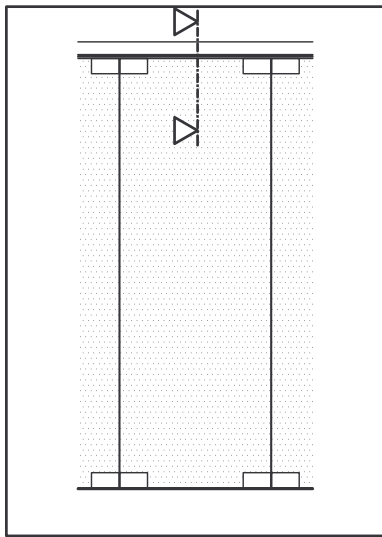

movingStar über: MONOWA Flexible Trennwandsysteme GmbH, Austraße 28, 71739 Oberriexingen



Produkt / product

movingStar / manuell

Maßstab / scale 1 : 2,5

Beschreibung / description

Vertikalschnitt Glaselement
Deckenanschluss

Blatt Nr. / no. sheet
movingSTAR
007

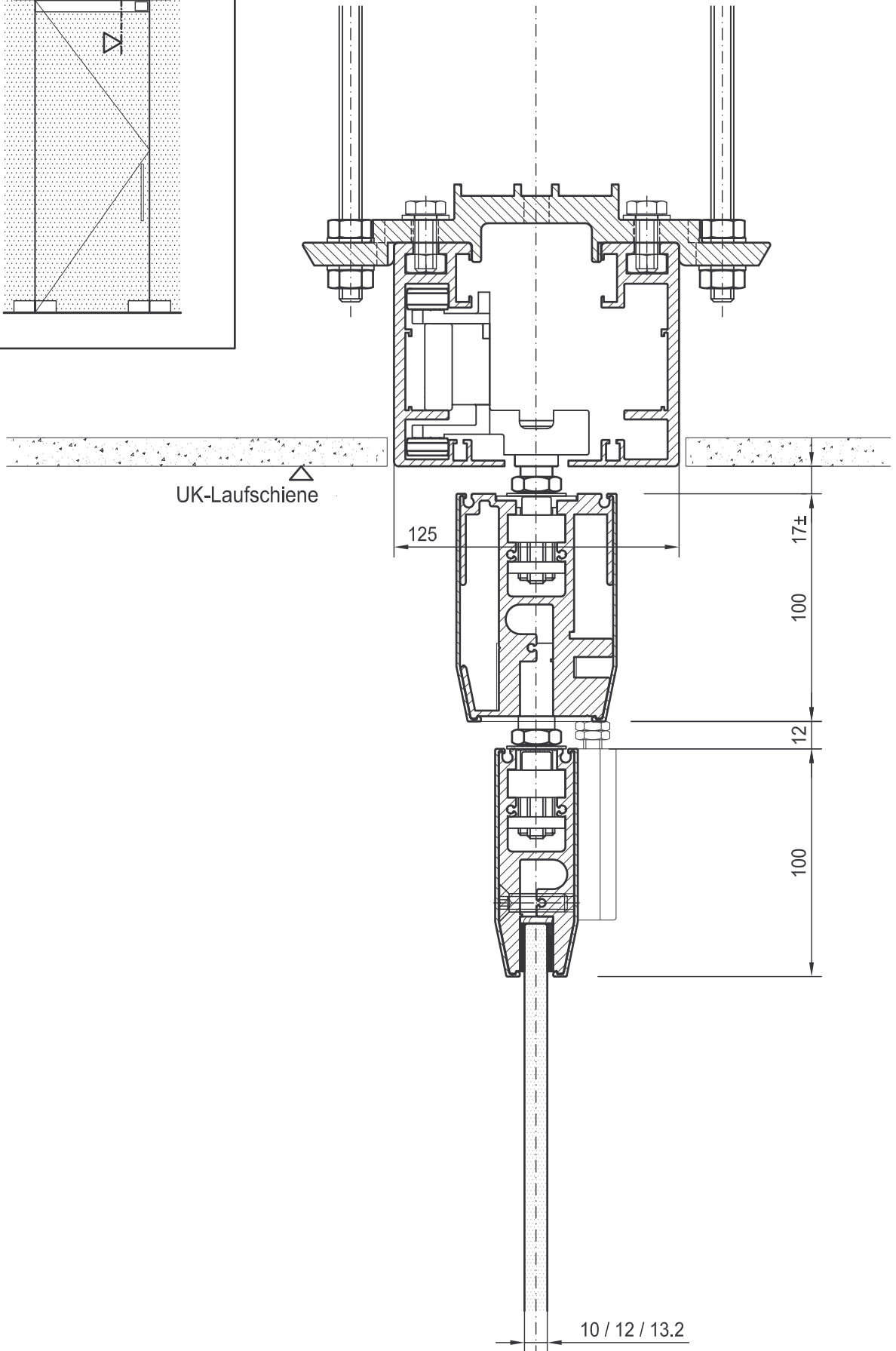
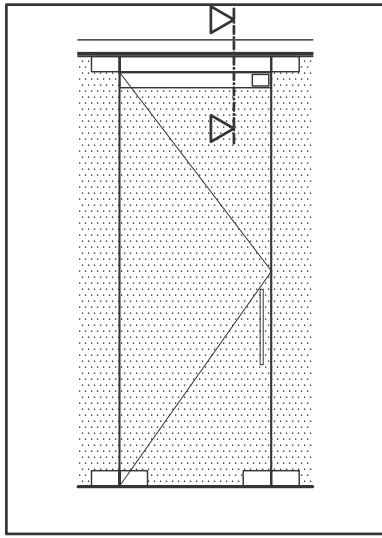

movingStar über: MONOWA Flexible Trennwandsysteme GmbH, Austraße 28, 71739 Oberriexingen



Produkt / product

movingStar / manuell

Maßstab / scale 1 : 2,5

Beschreibung / description

Vertikalschnitt Türelement
Deckenanschluss ohne Oberlicht

Blatt Nr. / no. sheet
movingSTAR
008

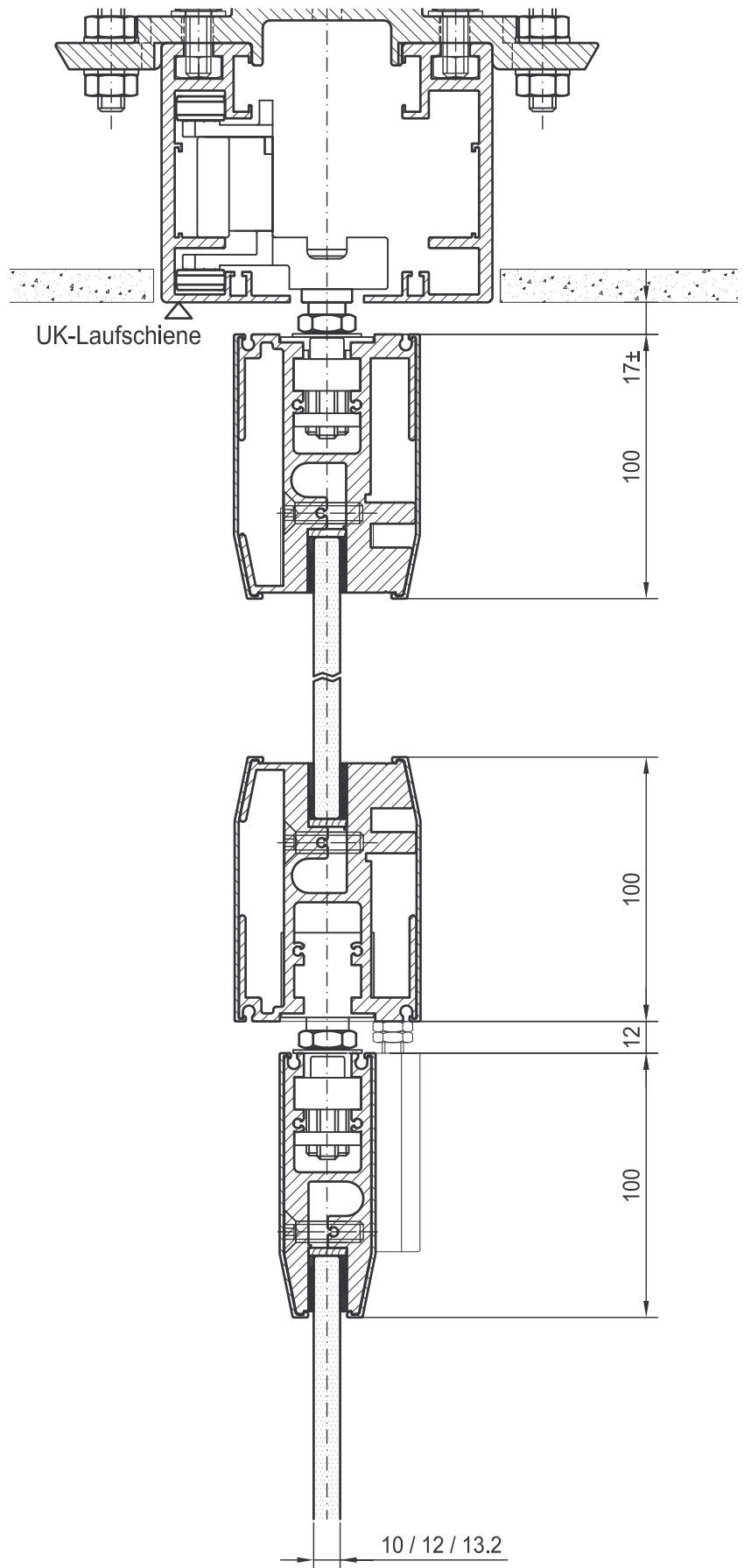
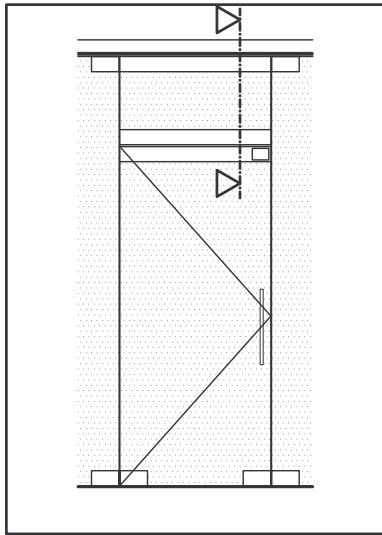

movingStar über: MONOWA Flexible Trennwandsysteme GmbH, Austraße 28, 71739 Oberriexingen



Produkt / product

movingStar / manuell

Maßstab / scale 1 : 2,5

Beschreibung / description

Vertikalschnitt Türelement
Deckenanschluss mit Oberlicht

Blatt Nr. / no. sheet
movingSTAR
009

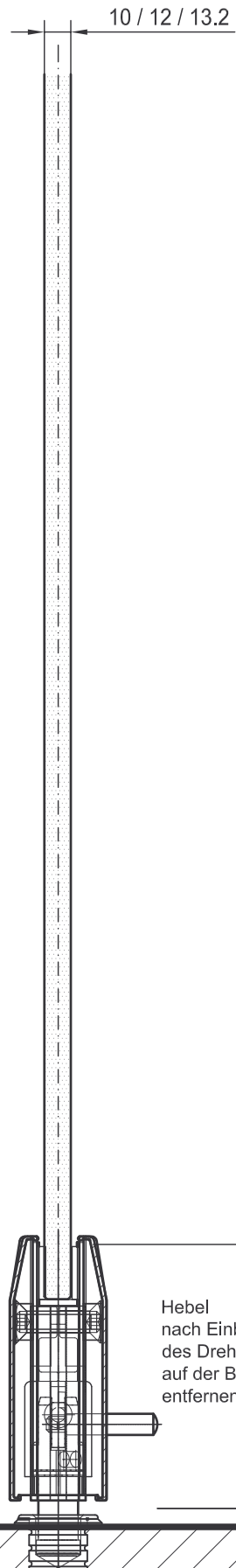
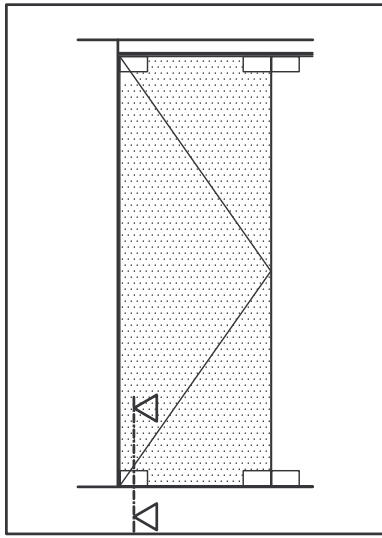

movingStar über: MONOWA Flexible Trennwandsysteme GmbH, Austraße 28, 71739 Oberriexingen



Produkt / product

movingStar

Maßstab / scale 1 : 2,5

Beschreibung / description

Vertikalschnitt Bodenanschluss
Drehendflügel Bandseite

Blatt Nr. / no. sheet
movingSTAR
010

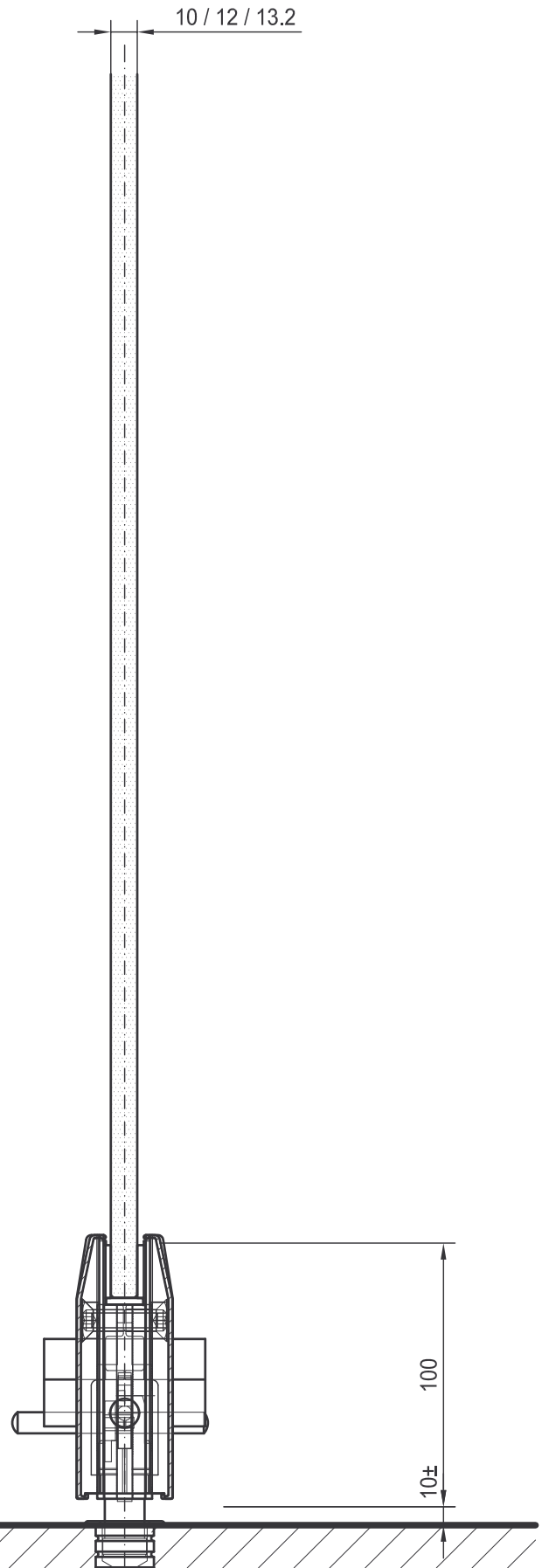
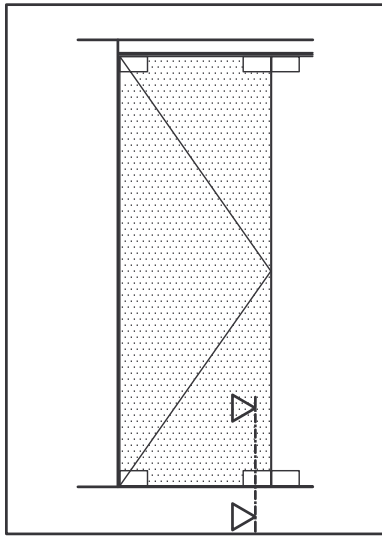

movingStar über: MONOWA Flexible Trennwandsysteme GmbH, Austraße 28, 71739 Oberriexingen



Produkt / product

movingStar

Maßstab / scale 1 : 2,5

Beschreibung / description

Vertikalschnitt Bodenanschluss
Drehendflügel Schlossseite

Blatt Nr. / no. sheet
movingSTAR
011

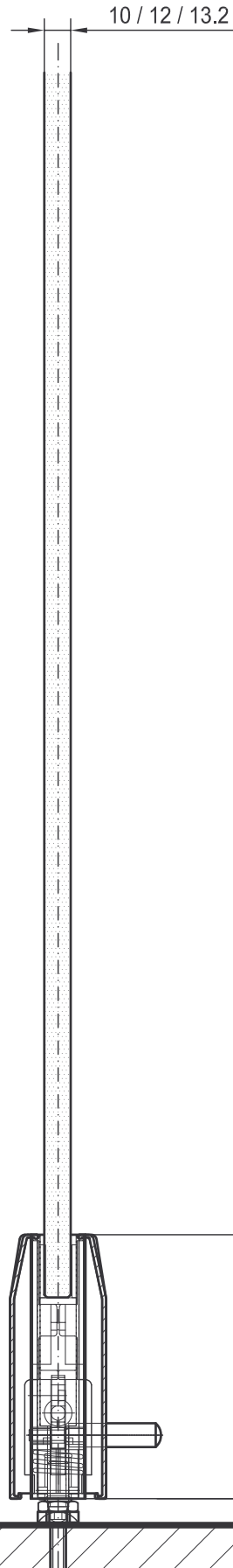
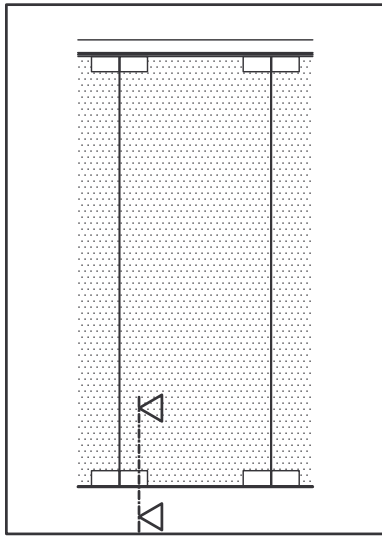

movingStar über: MONOWA Flexible Trennwandsysteme GmbH, Austraße 28, 71739 Oberriexingen



Produkt / product

movingStar

Maßstab / scale 1 : 2,5

Beschreibung / description

Vertikalschnitt Bodenanschluss
Normalelement Links / Normalelement

Blatt Nr. / no. sheet
movingSTAR
012

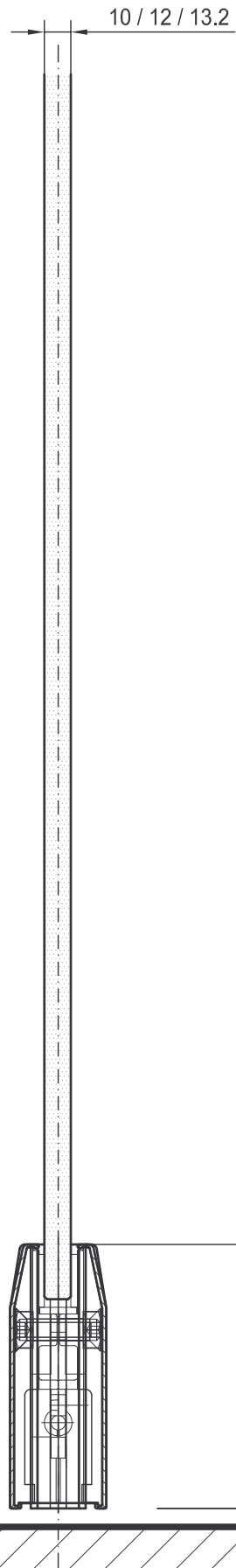
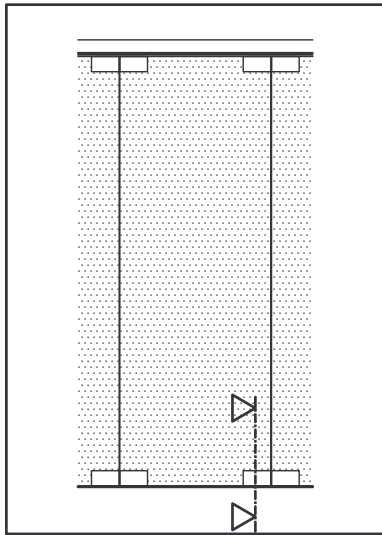

movingStar über: MONOWA Flexible Trennwandsysteme GmbH, Austraße 28, 71739 Oberriexingen



Produkt / product

movingStar

Maßstab / scale 1 : 2,5

Beschreibung / description

Vertikalschnitt Bodenanschluss
Normalelement Rechts / Normalelement

Blatt Nr. / no. sheet
movingSTAR
013

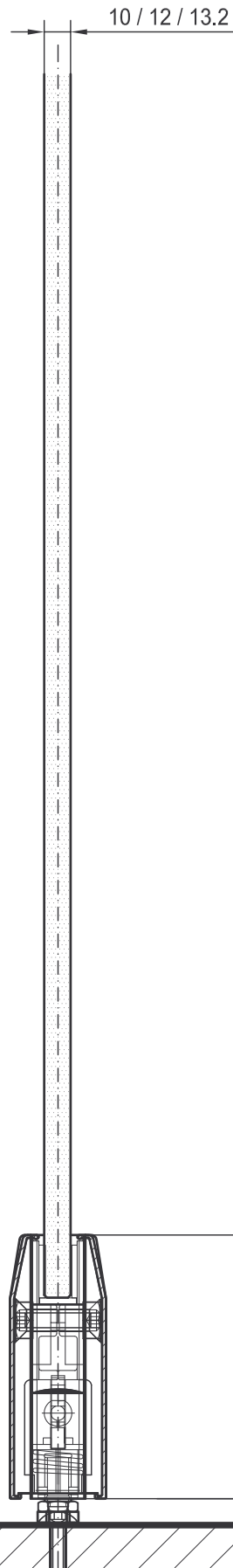
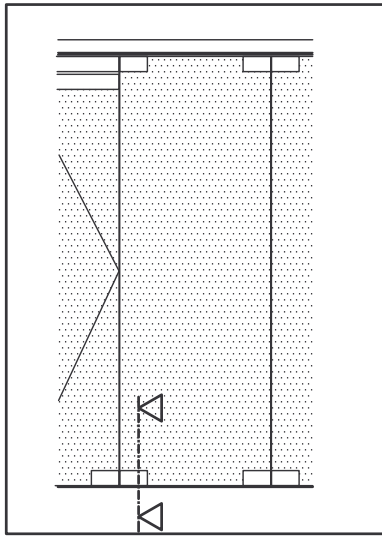

movingStar über: MONOWA Flexible Trennwandsysteme GmbH, Austraße 28, 71739 Oberriexingen

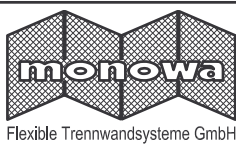

Produkt / product

movingStar

Maßstab / scale 1 : 2,5

Beschreibung / description

Vertikalschnitt Bodenanschluss
Normalelement Links / Drehflügel

Blatt Nr. / no. sheet
movingSTAR
014

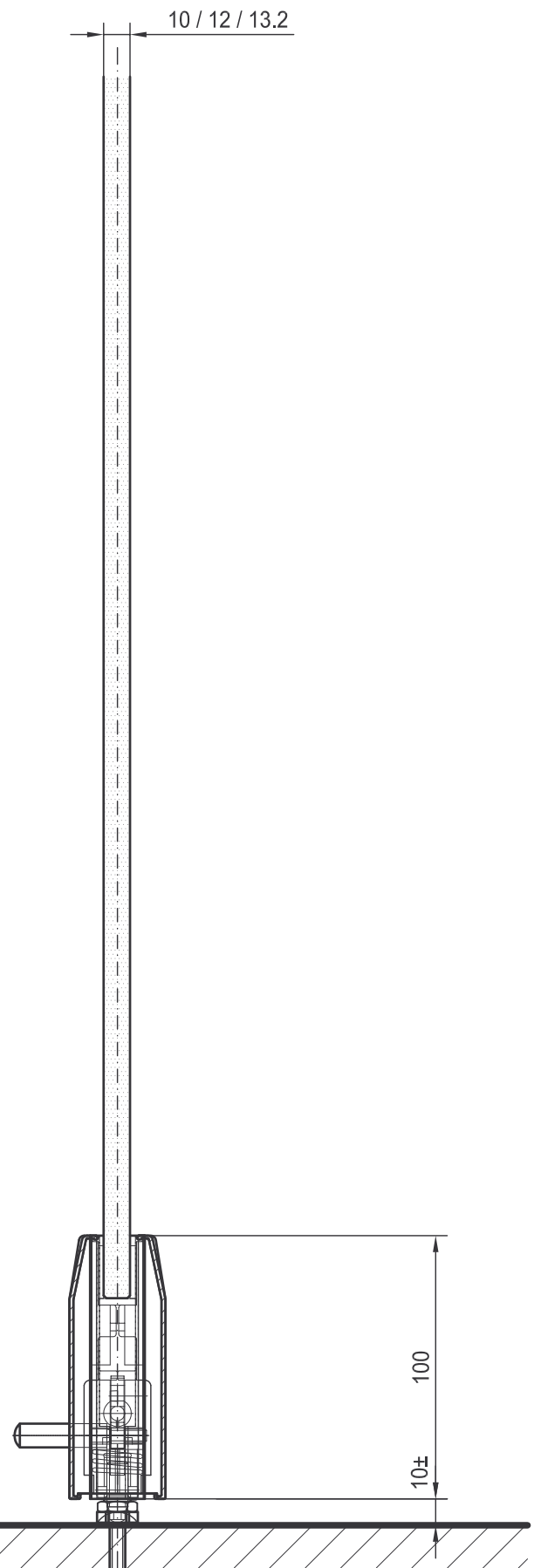
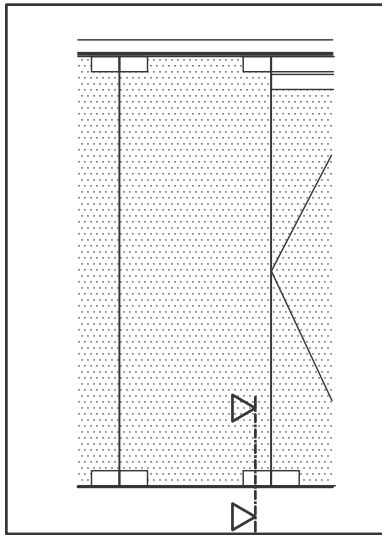

movingStar über: MONOWA Flexible Trennwandsysteme GmbH, Austraße 28, 71739 Oberriexingen



Produkt / product

movingStar

Maßstab / scale 1 : 2,5

Beschreibung / description

Vertikalschnitt Bodenanschluss
Normalelement Rechts / Drehflügel

Blatt Nr. / no. sheet
movingSTAR
015

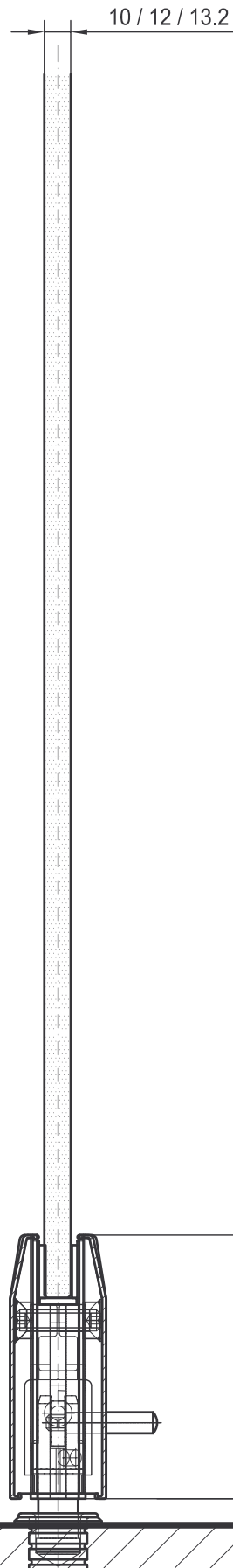
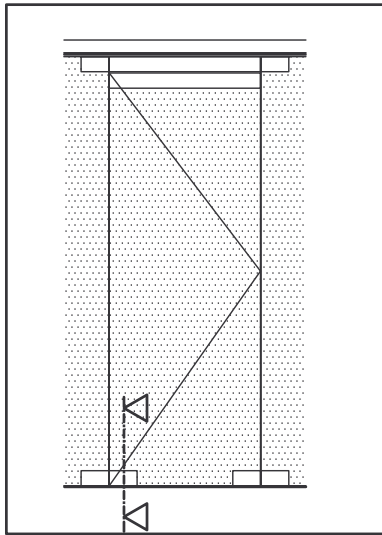

OK FFB

movingStar über: MONOWA Flexible Trennwandsysteme GmbH, Austraße 28, 71739 Oberriexingen



Produkt / product

movingStar

Maßstab / scale 1 : 2,5

Beschreibung / description

Vertikalschnitt Bodenanschluss
Drehflügel DIN R - Bandseite

Blatt Nr. / no. sheet
movingSTAR
016

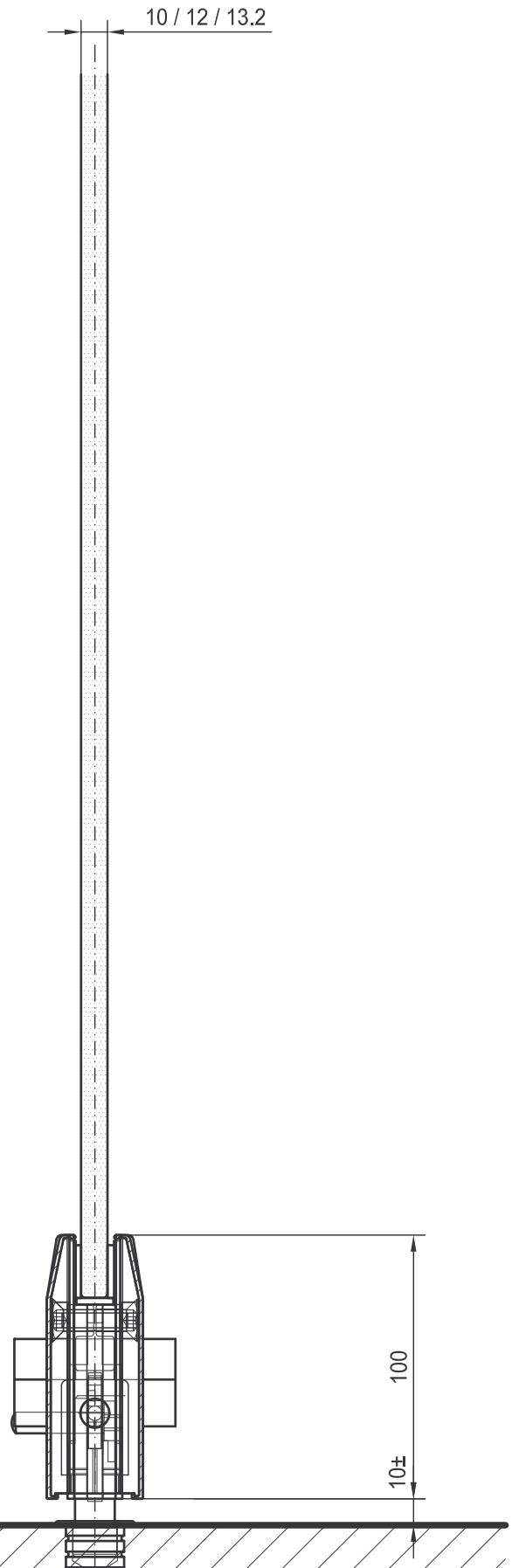
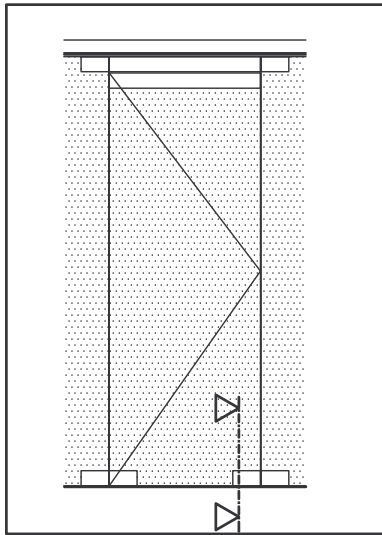

movingStar über: MONOWA Flexible Trennwandsysteme GmbH, Austraße 28, 71739 Oberriexingen



Produkt / product

movingStar

Maßstab / scale 1 : 2,5

Beschreibung / description

Vertikalschnitt Bodenanschluss
Drehflügel DIN R - Schlossseite

Blatt Nr. / no. sheet
movingSTAR
017

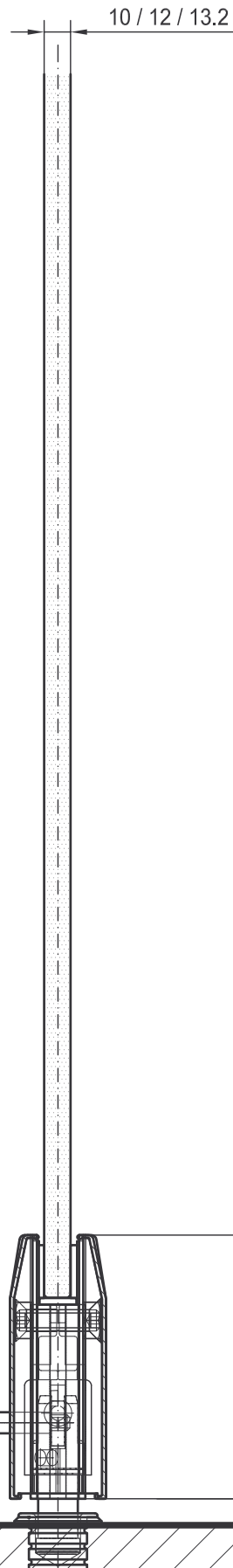
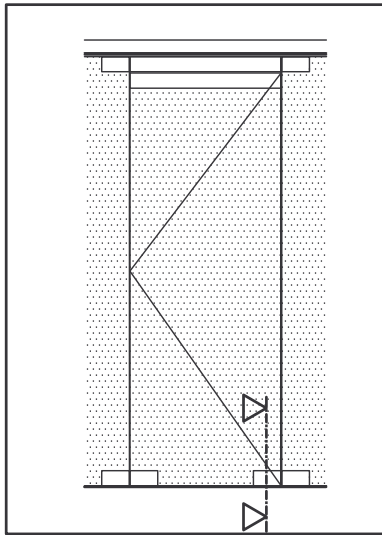

movingStar über: MONOWA Flexible Trennwandsysteme GmbH, Austraße 28, 71739 Oberriexingen

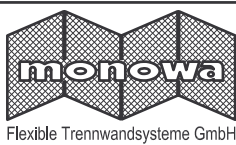

Produkt / product

movingStar

Maßstab / scale 1 : 2,5

Beschreibung / description

**Vertikalschnitt Bodenanschluss
Drehflügel DIN L - Bandseite**

Blatt Nr. / no. sheet
**movingSTAR
018**

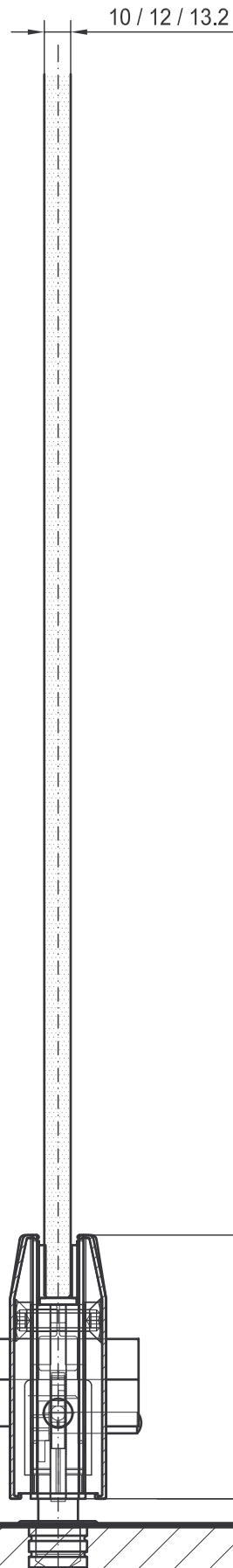
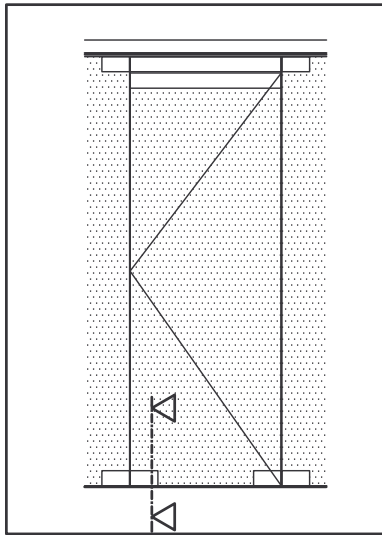

movingStar über: MONOWA Flexible Trennwandsysteme GmbH, Austraße 28, 71739 Oberriexingen



Produkt / product

movingStar

Maßstab / scale 1 : 2,5

Beschreibung / description

Vertikalschnitt Bodenanschluss
Drehflügel DIN L - Schlossseite

Blatt Nr. / no. sheet
movingSTAR
019

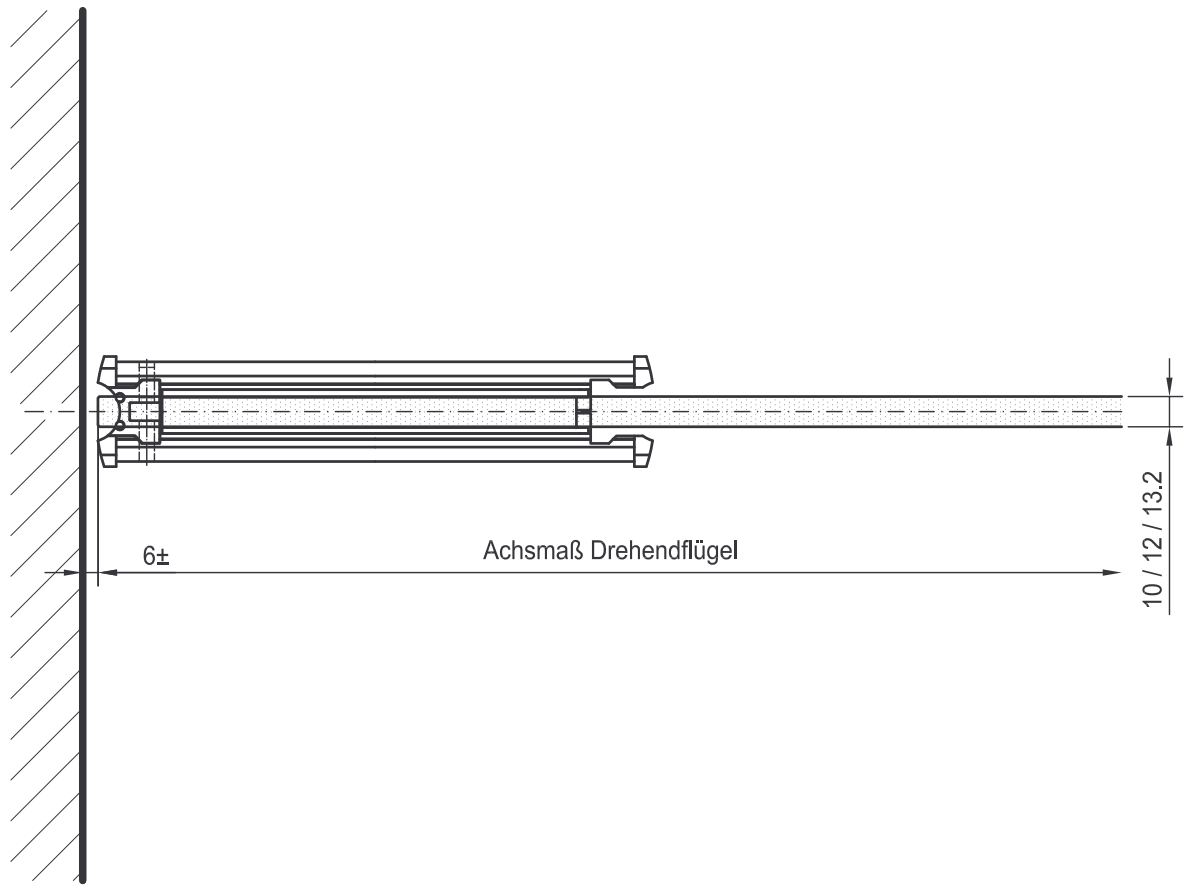
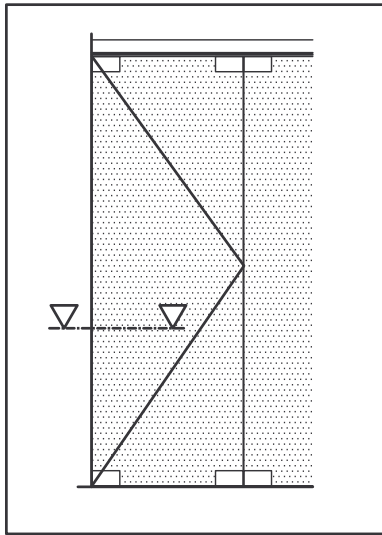

movingStar über: MONOWA Flexible Trennwandsysteme GmbH, Austraße 28, 71739 Oberriexingen



Produkt / product

movingStar

Maßstab / scale 1 : 2,5

Beschreibung / description

Horizontalschnitt
Drehendflügel; Bandseite

Blatt Nr. / no. sheet
movingSTAR
020

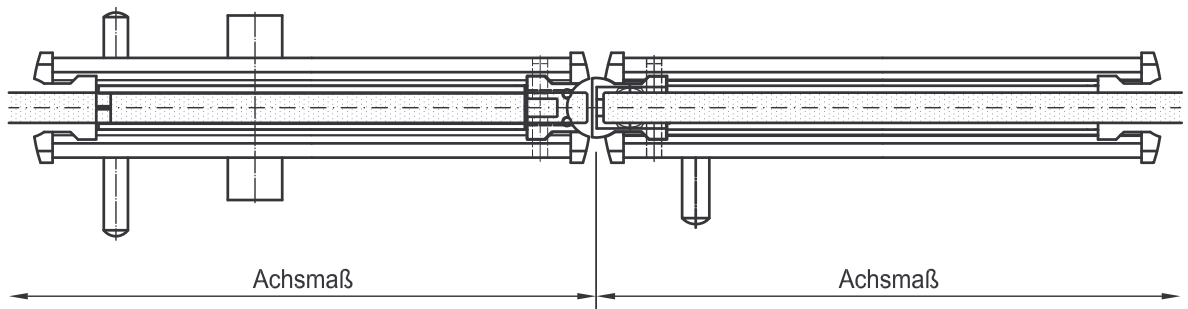
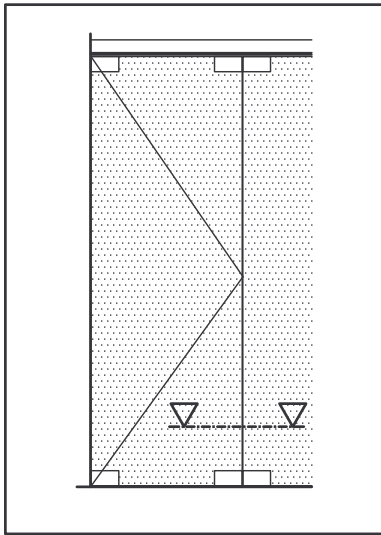

movingStar über: MONOWA Flexible Trennwandsysteme GmbH, Austraße 28, 71739 Oberriexingen

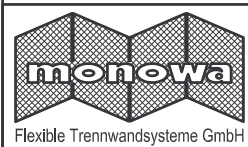

Produkt / product

movingStar

Maßstab / scale 1 : 2,5

Beschreibung / description

Horizontalschnitt Drehendflügel /
Normalelement; Schlosseite Rechts

Blatt Nr. / no. sheet
movingSTAR
021

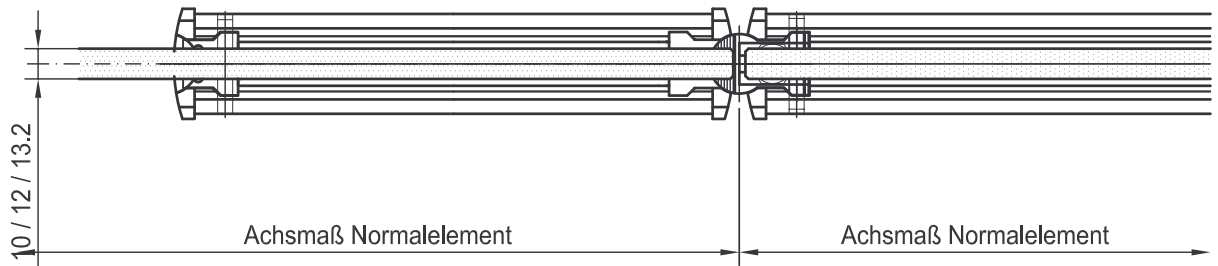
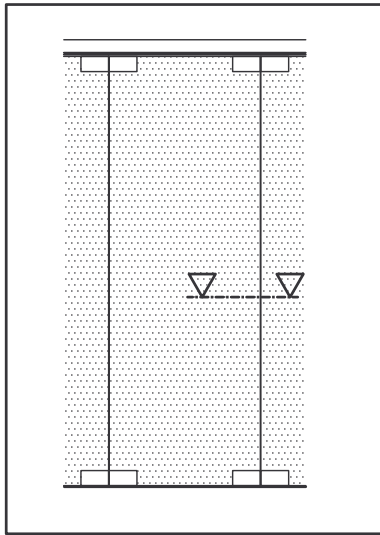

movingStar über: MONOWA Flexible Trennwandsysteme GmbH, Austraße 28, 71739 Oberriexingen

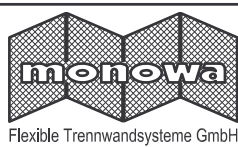

Produkt / product

movingStar

Maßstab / scale 1 : 2,5

Beschreibung / description

Horizontalschnitt Normalelement

Blatt Nr. / no. sheet
movingSTAR
022

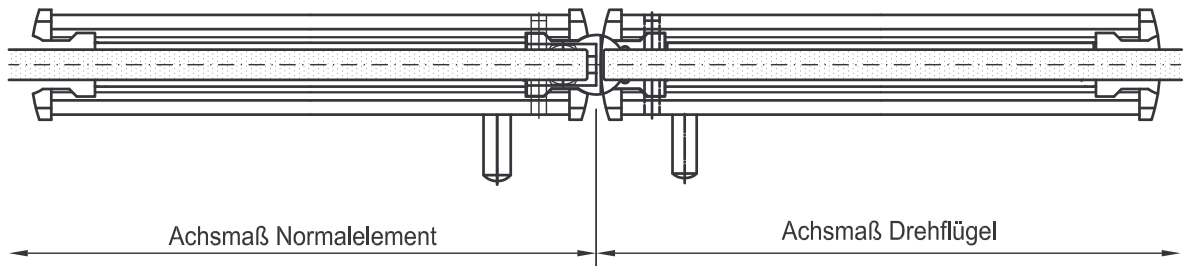
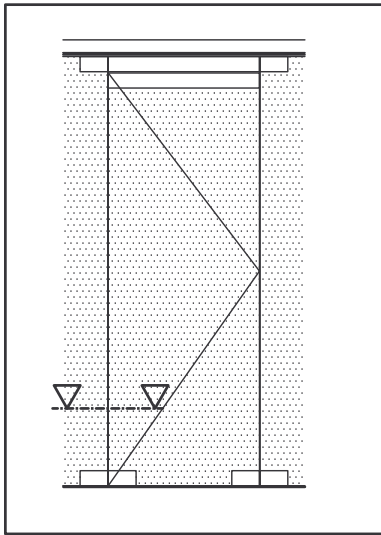

movingStar über: MONOWA Flexible Trennwandsysteme GmbH, Austraße 28, 71739 Oberriexingen

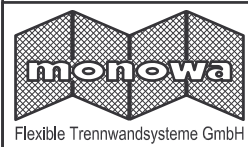

Produkt / product

movingStar

Maßstab / scale 1 : 2,5

Beschreibung / description

Horizontalschnitt Drehflügel /
Normalelement; Bandseite Links

Blatt Nr. / no. sheet
movingSTAR
023

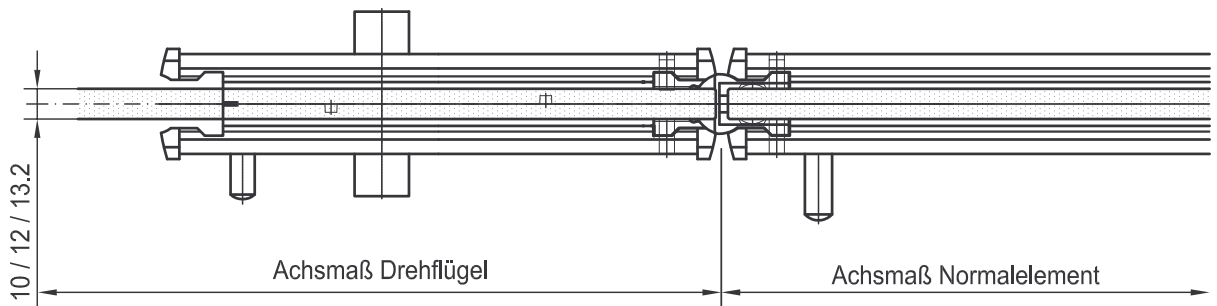
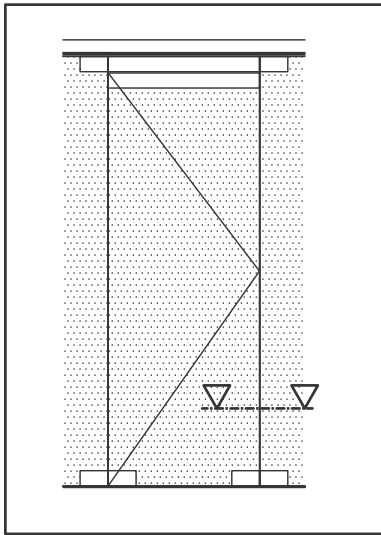

movingStar über: MONOWA Flexible Trennwandsysteme GmbH, Austraße 28, 71739 Oberriexingen



Produkt / product

movingStar

Maßstab / scale 1 : 2,5

Beschreibung / description

Horizontalschnitt Drehflügel /
Normalelement; Schlossseite Rechts

Blatt Nr. / no. sheet
movingSTAR
024

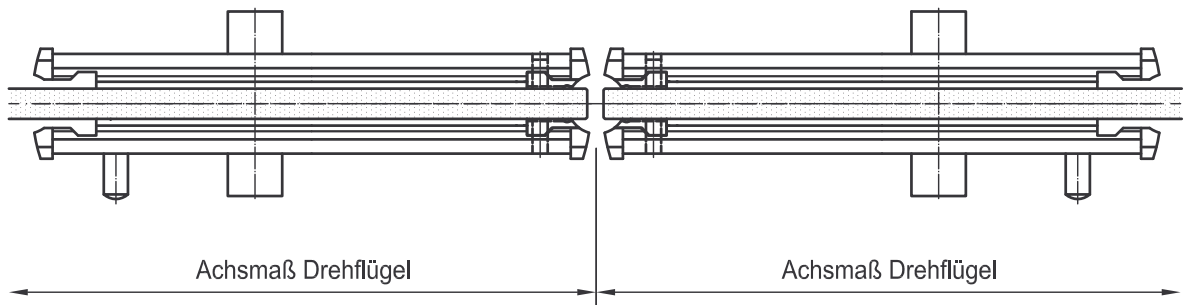
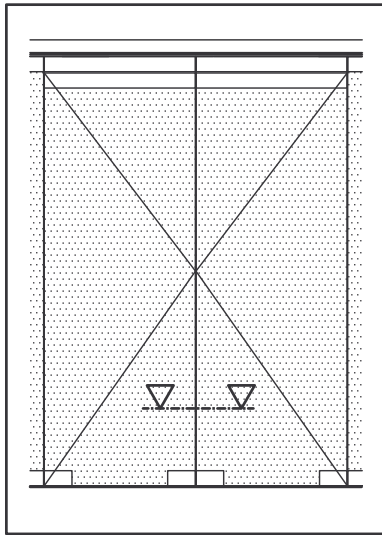

movingStar über: MONOWA Flexible Trennwandsysteme GmbH, Austraße 28, 71739 Oberriexingen

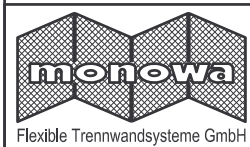

Produkt / product

movingStar

Maßstab / scale 1 : 2,5

Beschreibung / description

Horizontalschnitt
Doppel-Drehflügel - Schlossbereich

Blatt Nr. / no. sheet
movingSTAR
025

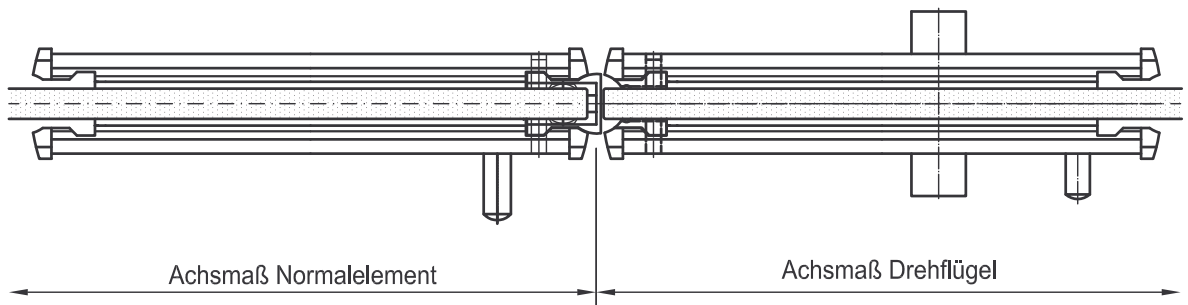
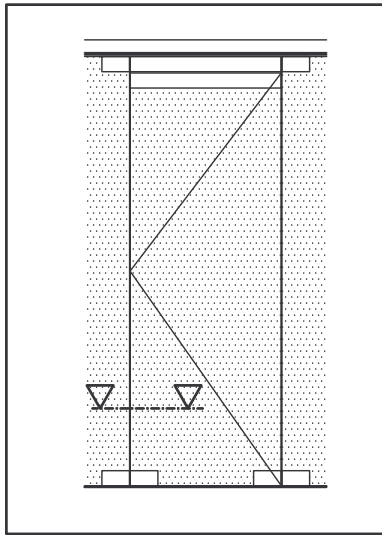

movingStar über: MONOWA Flexible Trennwandsysteme GmbH, Austraße 28, 71739 Oberriexingen



Produkt / product

movingStar

Maßstab / scale 1 : 2,5

Beschreibung / description

Horizontalschnitt
Drehflügel; Schlossseite Links

Blatt Nr. / no. sheet
movingSTAR
026

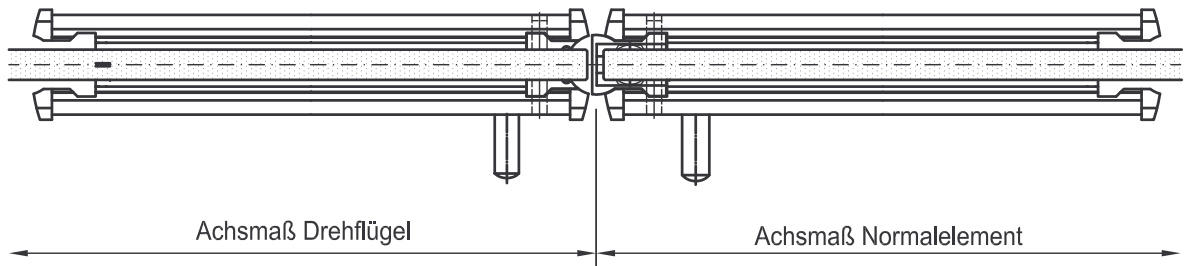
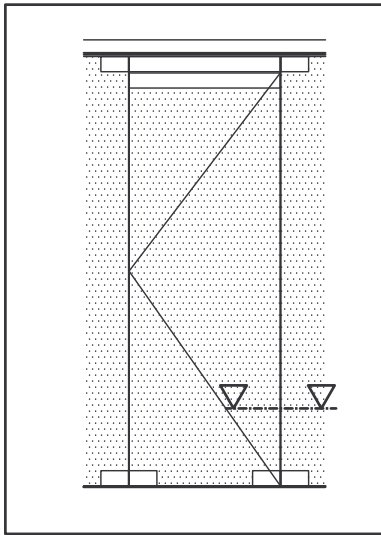

movingStar über: MONOWA Flexible Trennwandsysteme GmbH, Austraße 28, 71739 Oberriexingen

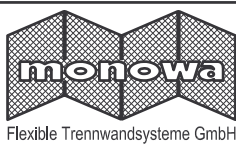

Produkt / product

movingStar

Maßstab / scale 1 : 2,5

Beschreibung / description

Horizontalschnitt Drehflügel /
Normalelement; Bandseite Rechts

Blatt Nr. / no. sheet
movingSTAR
027

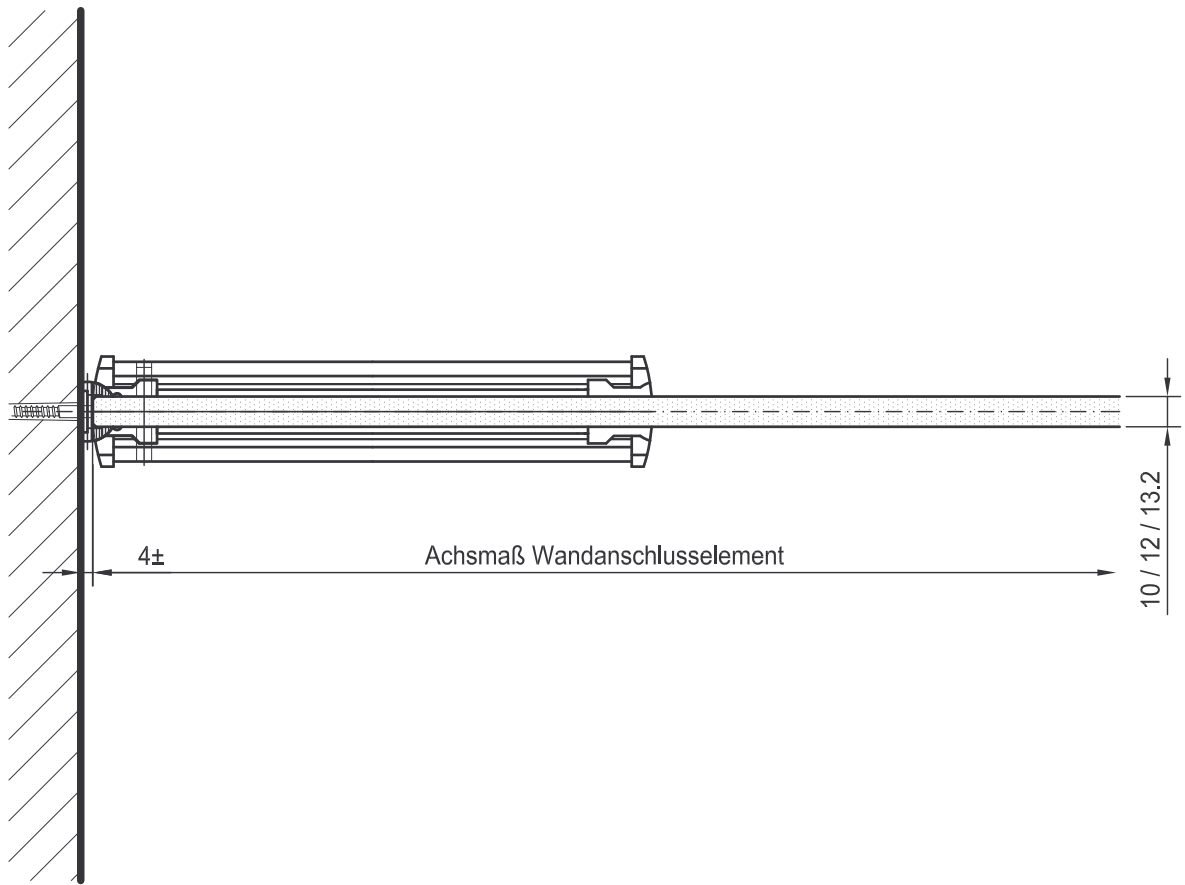
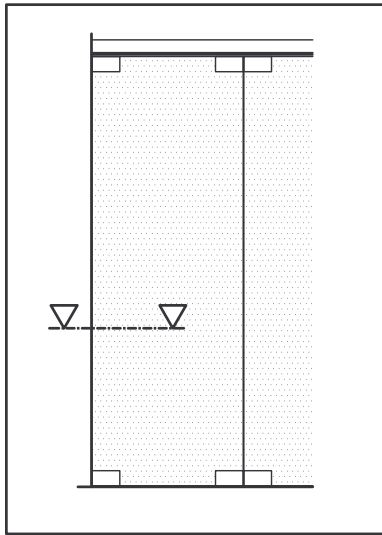

movingStar über: MONOWA Flexible Trennwandsysteme GmbH, Austraße 28, 71739 Oberriexingen



Produkt / product

movingStar

Maßstab / scale 1 : 2,5

Beschreibung / description

**Horizontalschnitt
Wandanschlusselement**

Blatt Nr. / no. sheet
**movingSTAR
028**